

**SEMISTOP® 2**

## Bridge Rectifier

### SK 70 B

Preliminary Data

#### Features

- Compact design
- One screw mounting
- Heat transfer and insulation through direct copper bonded aluminium oxide ceramic (DCB)
- Up 1600V reverse voltage
- High surge current
- Glass passivated diode chips
- UL recognized, file no. E 63 532

#### Typical Applications\*

- Input rectifier for power supplies
- Rectifier

| $V_{RSM}$<br>V | $V_{RRM}, V_{DRM}$<br>V | $I_D = 68 \text{ A (full conduction)}$<br>( $T_s = 80 \text{ °C}$ ) |
|----------------|-------------------------|---|
| 800            | 800                     | SK 70 B 08  |
| 1200           | 1200                    | SK 70 B 12  |
| 1600           | 1600                    | SK 70 B 16  |

| Symbol        | Conditions  | Values        | Units  |
|---------------|---|---------------|--|
| $I_D$         | $T_s = 80 \text{ °C}$   | 68            | A  |
| $I_{FSM}$     | $T_{vj} = 25 \text{ °C}; 10 \text{ ms}$<br>$T_{vj} = 125 \text{ °C}; 10 \text{ ms}$             | 700<br>560    | A<br>A                                       |
| $i^2t$        | $T_{vj} = 25 \text{ °C}; 8,3...10 \text{ ms}$<br>$T_{vj} = 125 \text{ °C}; 8,3...10 \text{ ms}$ | 2450<br>1370  | $\text{A}^2\text{s}$<br>$\text{A}^2\text{s}$ |
| $V_F$         | $T_{vj} = 25 \text{ °C}; I_F = 35 \text{ A}$  | max. 1,2      | V  |
| $V_{(TO)}$    | $T_{vj} = 125 \text{ °C}$   | max. 0,8      | V  |
| $r_T$         | $T_{vj} = 125 \text{ °C}$   | max. 11       | $\text{m}\Omega$                             |
| $I_{RD}$      | $T_{vj} = 150 \text{ °C}; V_{DD} = V_{DRM}; V_{RD} = V_{RRM}$                                   | max. 4        | mA<br>mA                                     |
| $R_{th(f-s)}$ | per diode<br>per module   | 1,2<br>0,3    | K/W<br>K/W                                   |
| $T_{solder}$  | terminals, 10s  | 260           | $\text{°C}$                                  |
| $T_{vj}$      |   | -40...+150    | $\text{°C}$                                  |
| $T_{stg}$     |   | -40...+125    | $\text{°C}$                                  |
| $V_{isol}$    | a. c. 50 Hz; r.m.s.; 1 s / 1 min.   | 3000 ( 2500 ) | V  |
| $M_s$         | mounting torque to heatsink   | 2             | Nm   |
| $M_t$         |   |               |  |
| m             | approx. weight  | 19            | g  |
| Case          | SEMISTOP® 2   | T 6           |  |

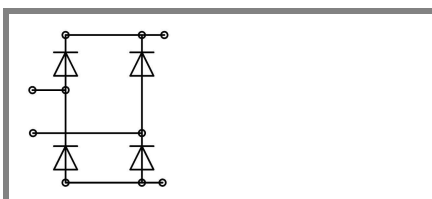

B

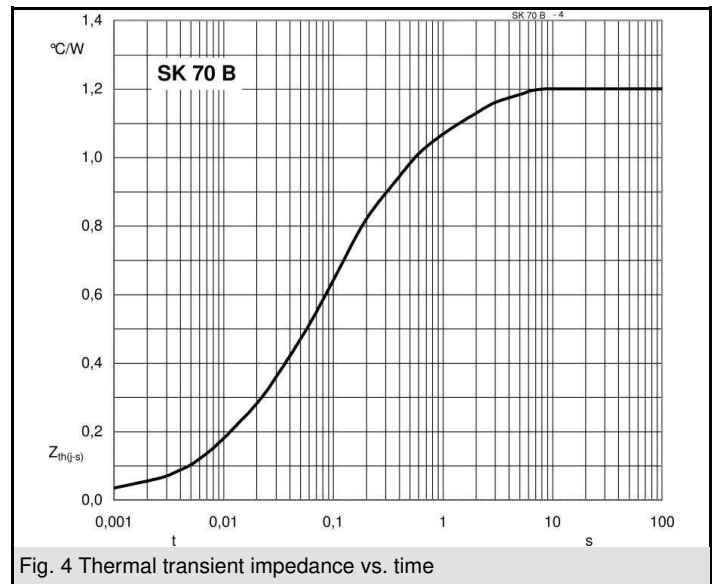
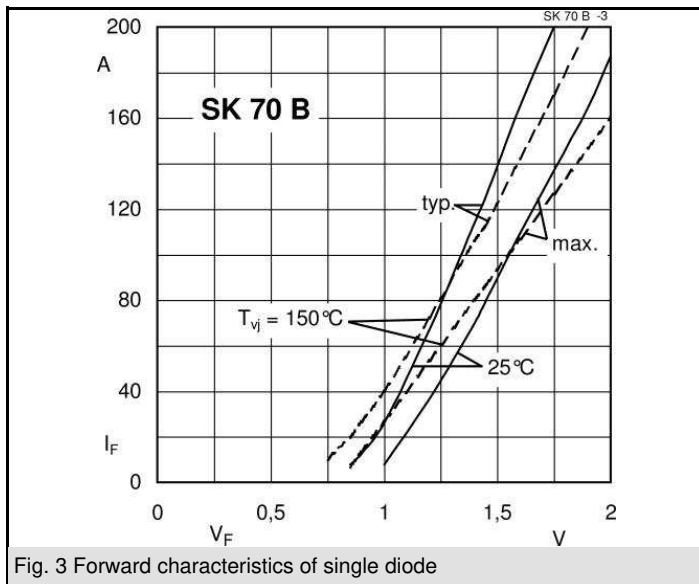
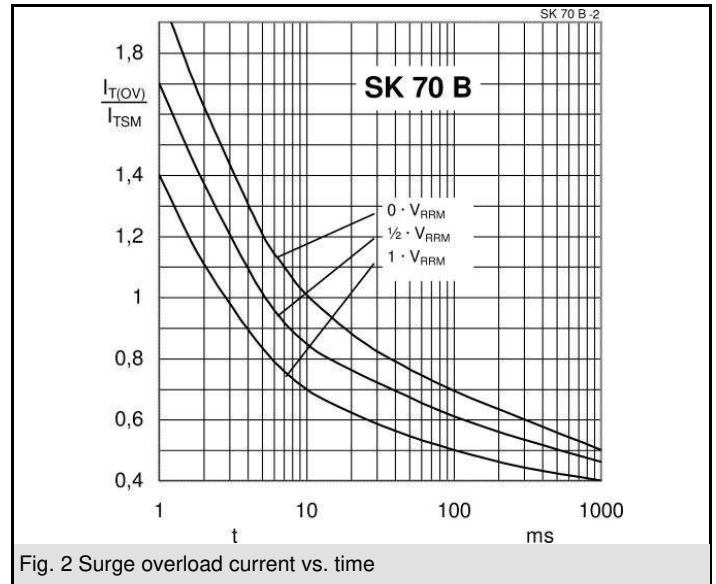
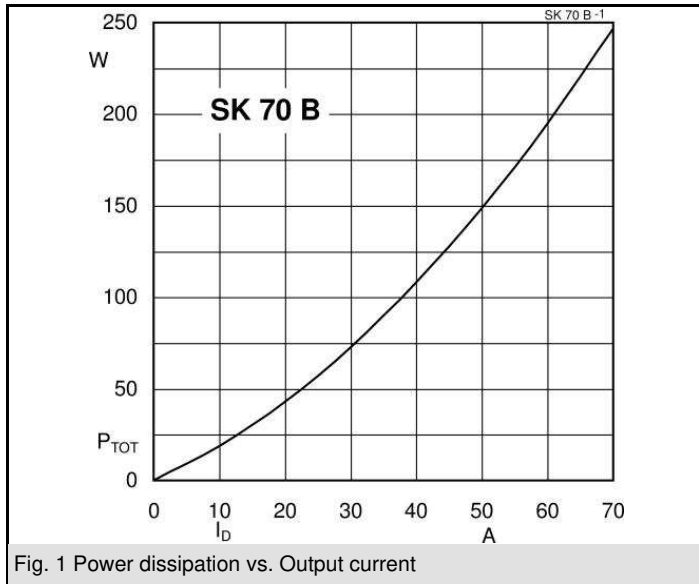

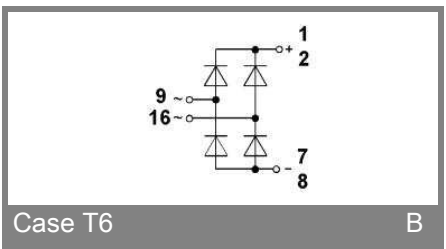
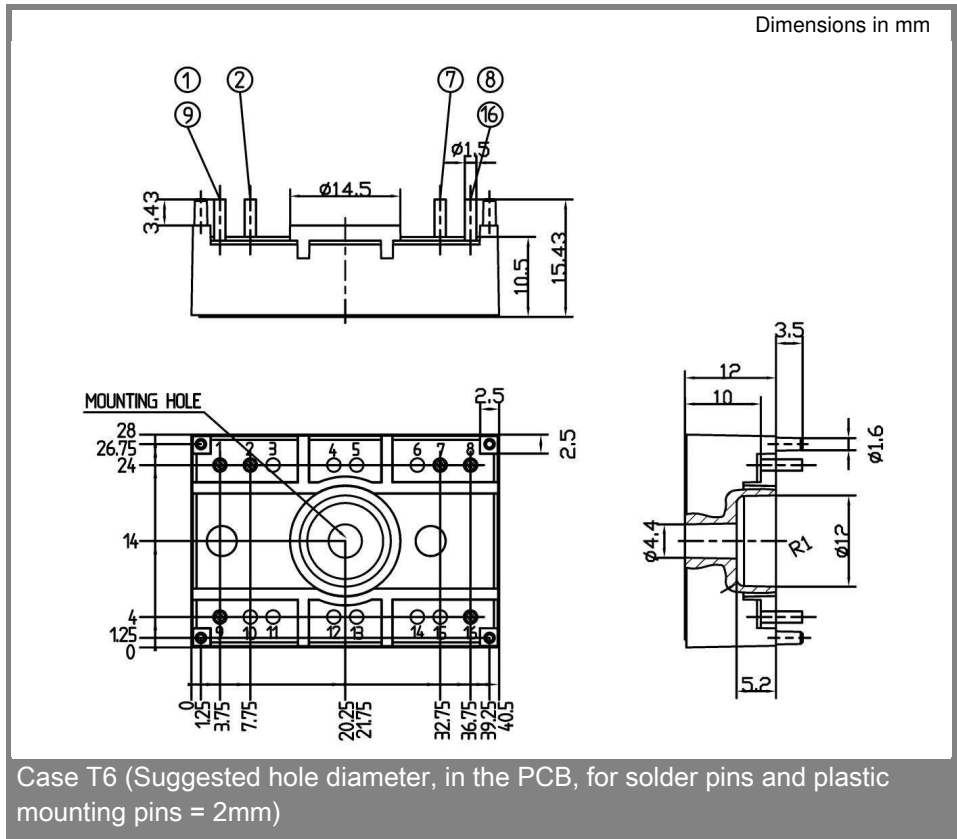

\* The specifications of our components may not be considered as an assurance of component characteristics. Components have to be tested for the respective application. Adjustments may be necessary. The use of SEMIKRON products in life support appliances and systems is subject to prior specification and written approval by SEMIKRON. We therefore strongly recommend prior consultation of our personal.