

SKMT 92, SKKL 92



SEMIPACK[®] 1

Thyristor / Diode Modules

SKKL 92

SKMT 92

Features

- Heat transfer through aluminium oxide ceramic isolated metal baseplate
- Hard soldered joints for high reliability
- UL recognized, file no. E 63 532

Typical Applications*

- Line rectifiers for transistorized AC motor controllers (SKKL)
- DC braking of AC motor (SKMT)

1) See the assembly instructions

V_{RSM} V	V_{RRM}, V_{DRM} V	$I_{TRMS} = 150$ A (maximum value for continuous operation) $I_{TAV} = 95$ A (sin. 180; $T_c = 85$ °C)	
900	800	SKMT 92/08E	
1300	1200		SKKL 92/12E
1500	1400	SKMT 92/14E	
1700	1600	SKMT 92/16E	SKKL 92/16E
1900	1800	SKMT 92/18E	

Symbol	Conditions	Values	Units
I_{TAV}	sin. 180; $T_c = 85$ (100) °C;	95 (68)	A
I_D	P3/180; $T_a = 45$ °C; B2 / B6	70 / 85	A
	P3/180F; $T_a = 35$ °C; B2 / B6	140 / 175	A
I_{RMS}	P3/180F; $T_a = 35$ °C; W1 / W3	190 / 3 * 135	A
I_{TSM}	$T_{vj} = 25$ °C; 10 ms	2000	A
	$T_{vj} = 125$ °C; 10 ms	1750	A
i^2t	$T_{vj} = 25$ °C; 8,3 ... 10 ms	20000	A ² s
	$T_{vj} = 125$ °C; 8,3 ... 10 ms	15000	A ² s
V_T	$T_{vj} = 25$ °C; $I_T = 300$ A	max. 1,65	V
$V_{T(TO)}$	$T_{vj} = 125$ °C	max. 0,9	V
r_T	$T_{vj} = 125$ °C	max. 2	mΩ
$I_{DD}; I_{RD}$	$T_{vj} = 125$ °C; $V_{RD} = V_{RRM}; V_{DD} = V_{DRM}$	max. 20	mA
t_{gd}	$T_{vj} = 25$ °C; $I_G = 1$ A; $di_G/dt = 1$ A/μs	1	μs
t_{gr}	$V_D = 0,67 * V_{DRM}$	2	μs
$(di/dt)_{cr}$	$T_{vj} = 125$ °C	max. 150	A/μs
$(dv/dt)_{cr}$	$T_{vj} = 125$ °C	max. 1000	V/μs
t_q	$T_{vj} = 125$ °C	100	μs
I_H	$T_{vj} = 25$ °C; typ. / max.	150 / 250	mA
I_L	$T_{vj} = 25$ °C; $R_G = 33$ Ω; typ. / max.	300 / 600	mA
V_{GT}	$T_{vj} = 25$ °C; d.c.	min. 3	V
I_{GT}	$T_{vj} = 25$ °C; d.c.	min. 150	mA
V_{GD}	$T_{vj} = 125$ °C; d.c.	max. 0,25	V
I_{GD}	$T_{vj} = 125$ °C; d.c.	max. 6	mA
$R_{th(j-c)}$	cont.; per thyristor / per module	0,28 / 0,14	K/W
$R_{th(j-c)}$	sin. 180; per thyristor / per module	0,3 / 0,15	K/W
$R_{th(j-c)}$	rec. 120; per thyristor / per module	0,32 / 0,16	K/W
$R_{th(c-s)}$	per thyristor / per module	0,2 / 0,1	K/W
T_{vj}		- 40 ... + 125	°C
T_{stg}		- 40 ... + 125	°C
V_{isol}	a. c. 50 Hz; r.m.s.; 1 s / 1 min.	3600 / 3000	V~
M_s	to heatsink	5 ± 15 % ¹⁾	Nm
M_t	to terminals	3 ± 15 %	Nm
a		5 * 9,81	m/s ²
m	approx.	95	g
Case	SKMT	A 72	
	SKKL	A 59	

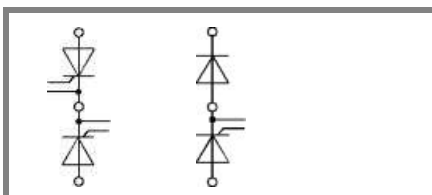

SKMT

SKKL

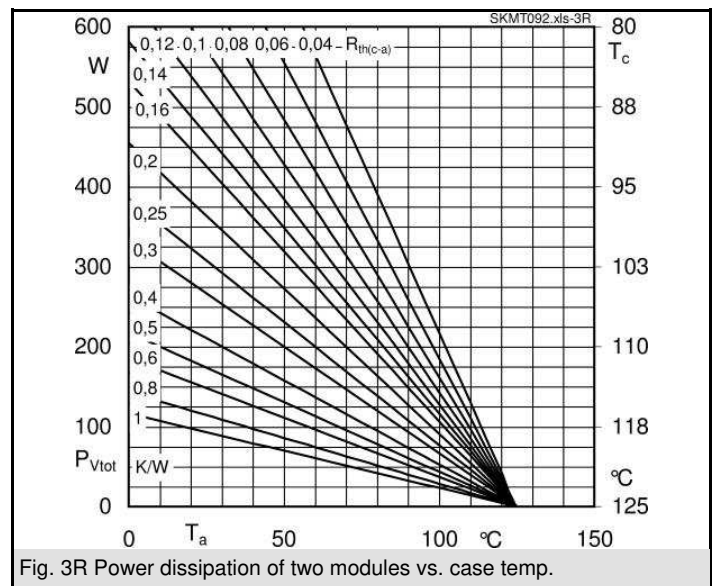
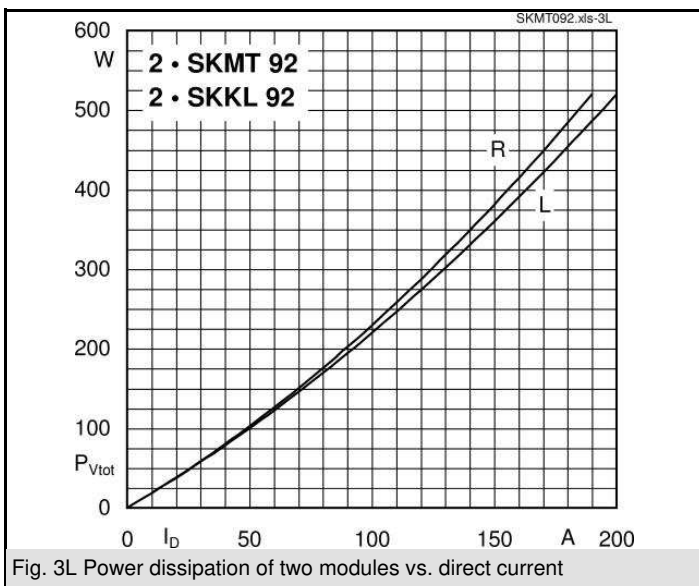
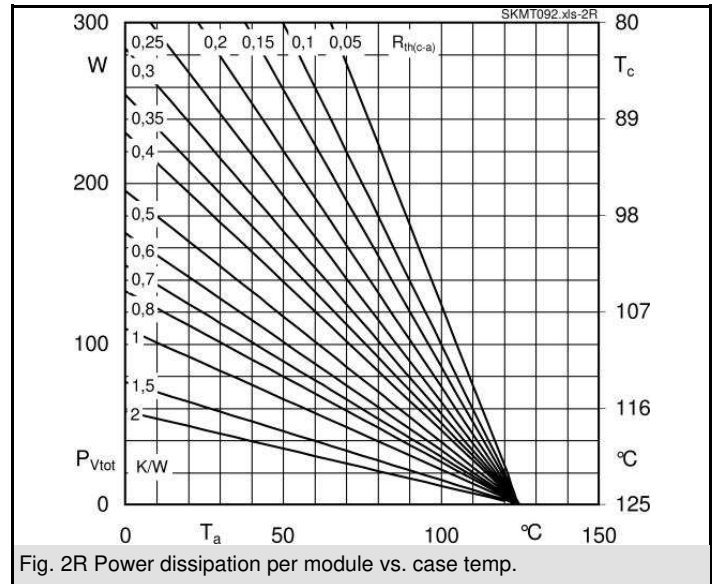
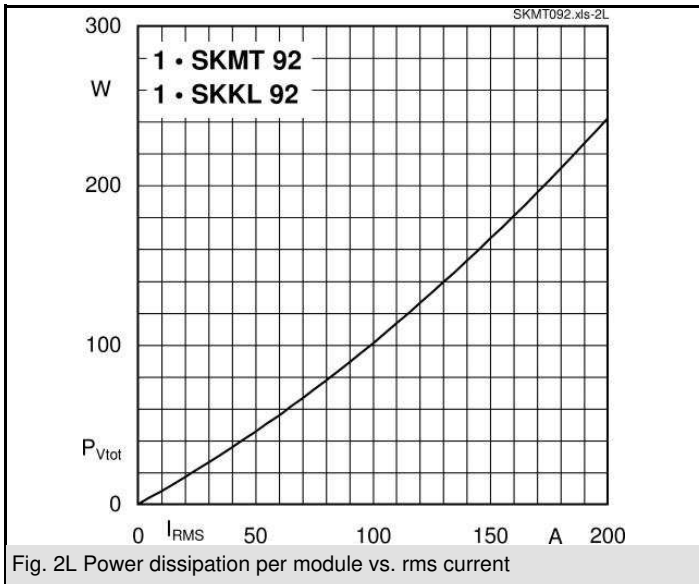
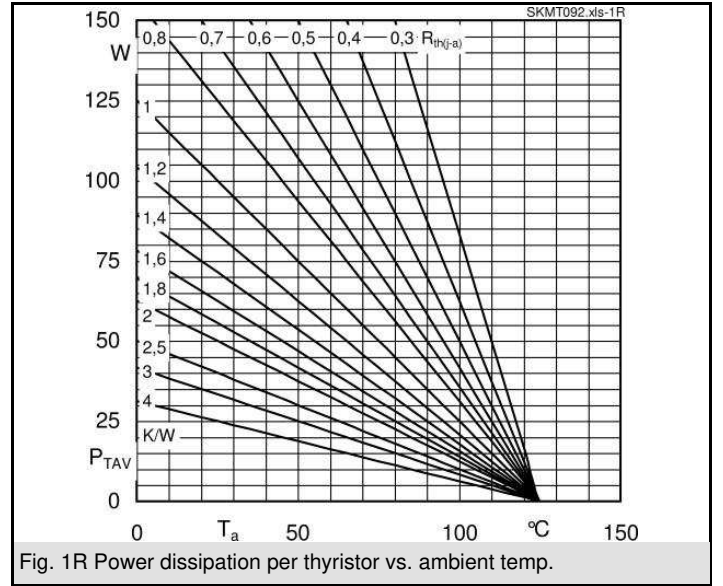
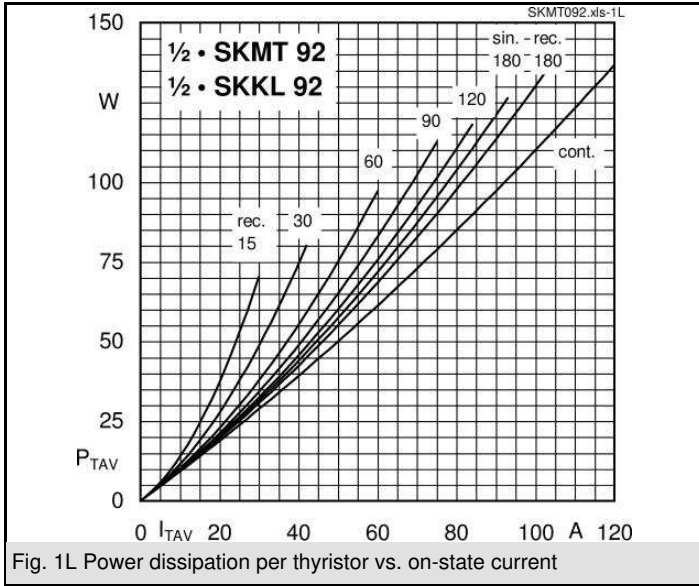

SKMT 92, SKKL 92

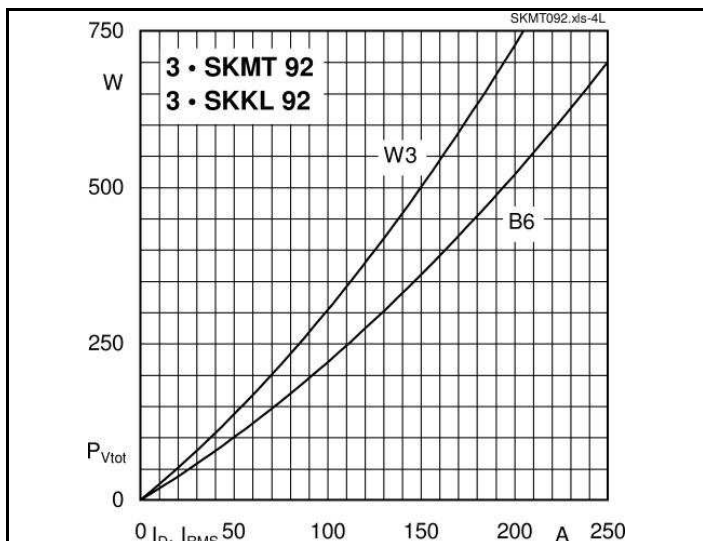

Fig. 4L Power dissipation of three modules vs. direct and rms current

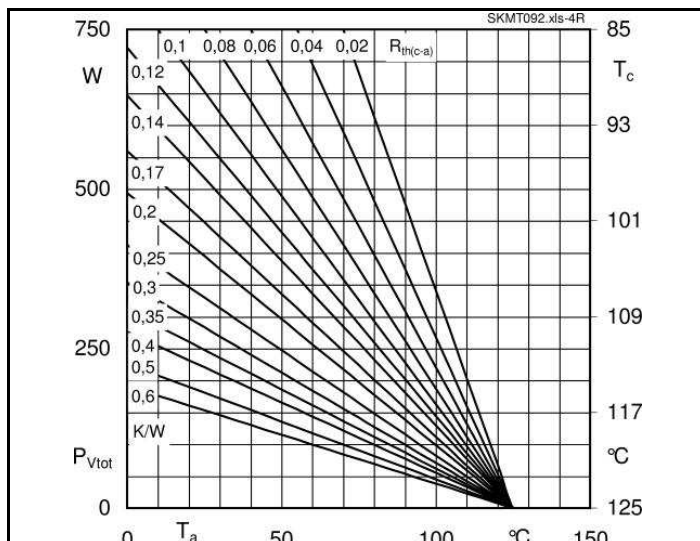

Fig. 4R Power dissipation of three modules vs. case temp.

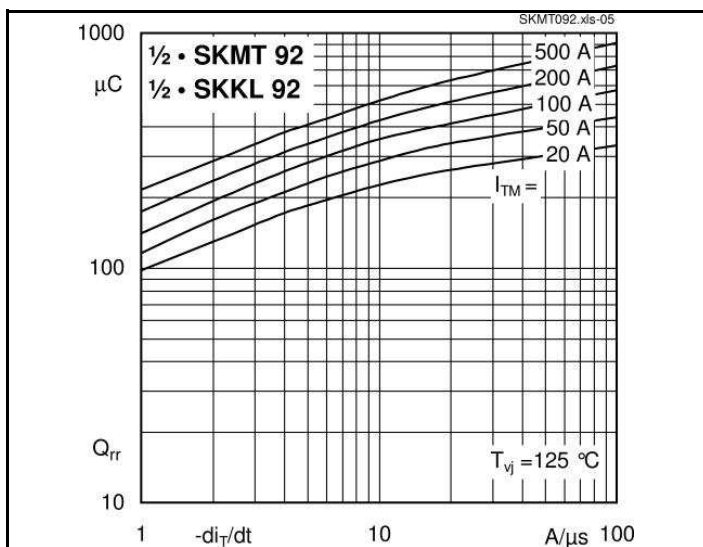

Fig. 5 Recovered charge vs. current decrease

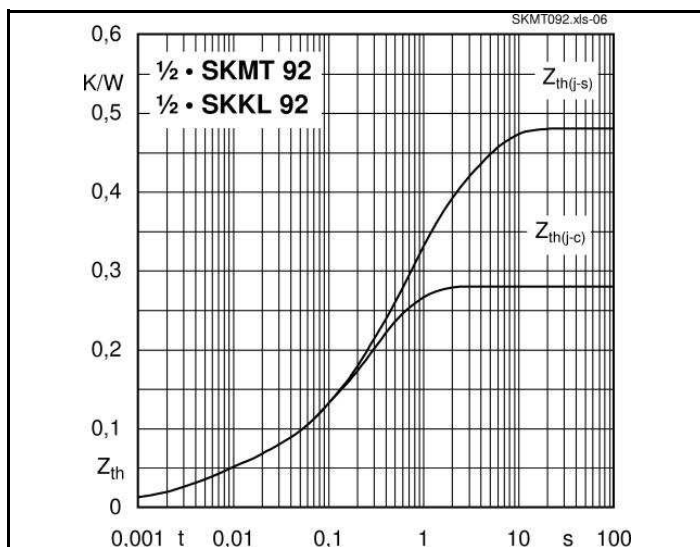

Fig. 6 Transient thermal impedance vs. time

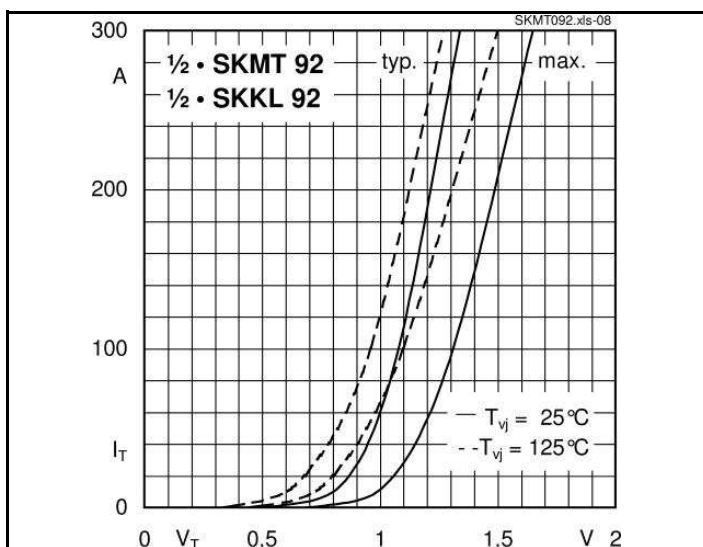

Fig. 7 On-state characteristics

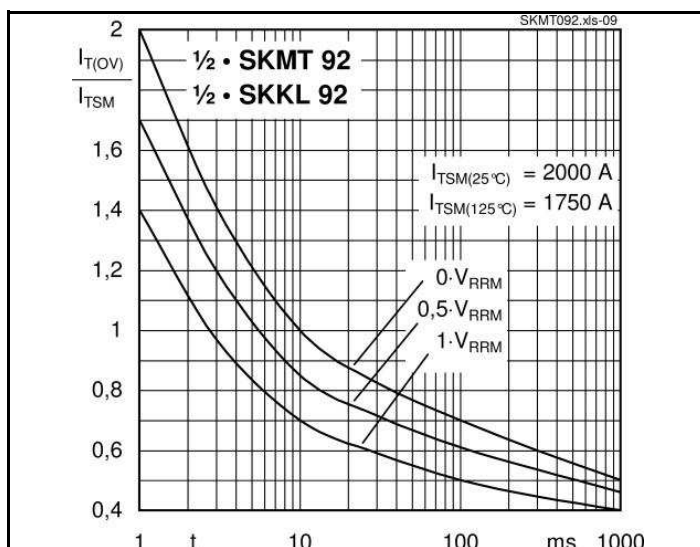
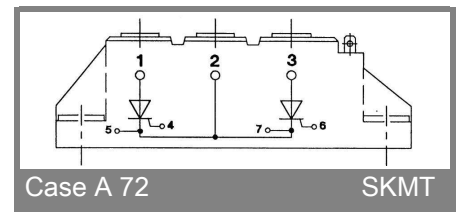
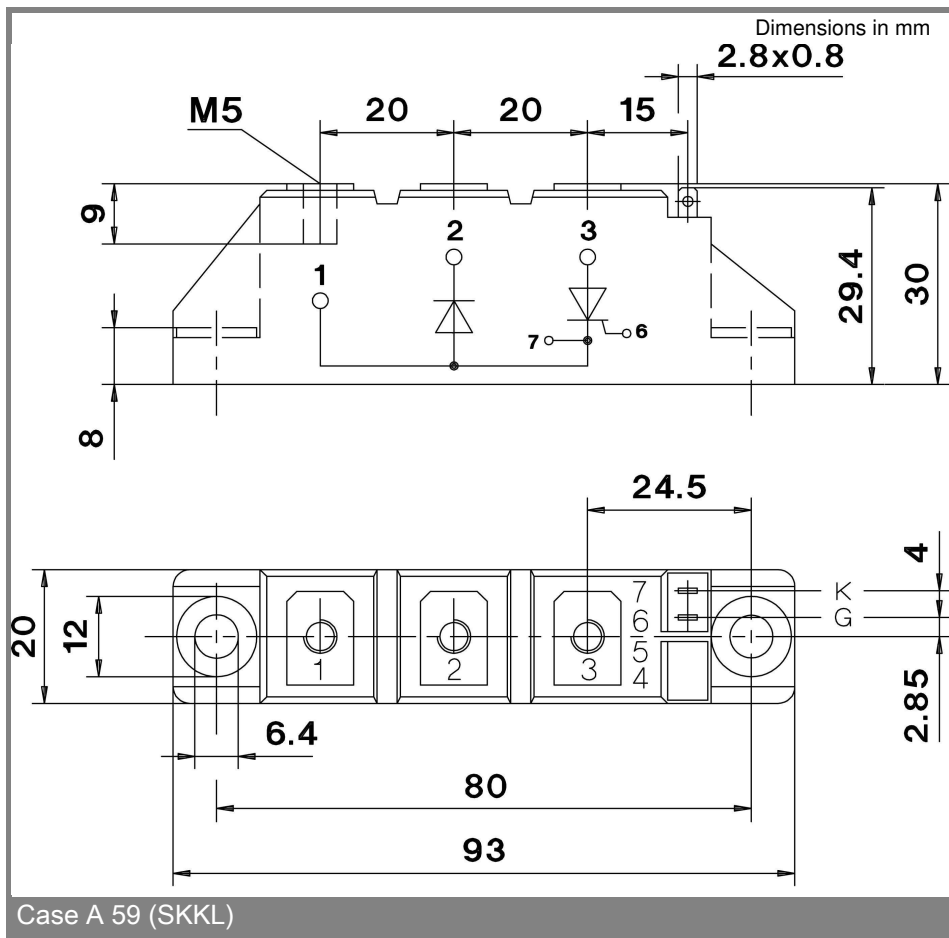
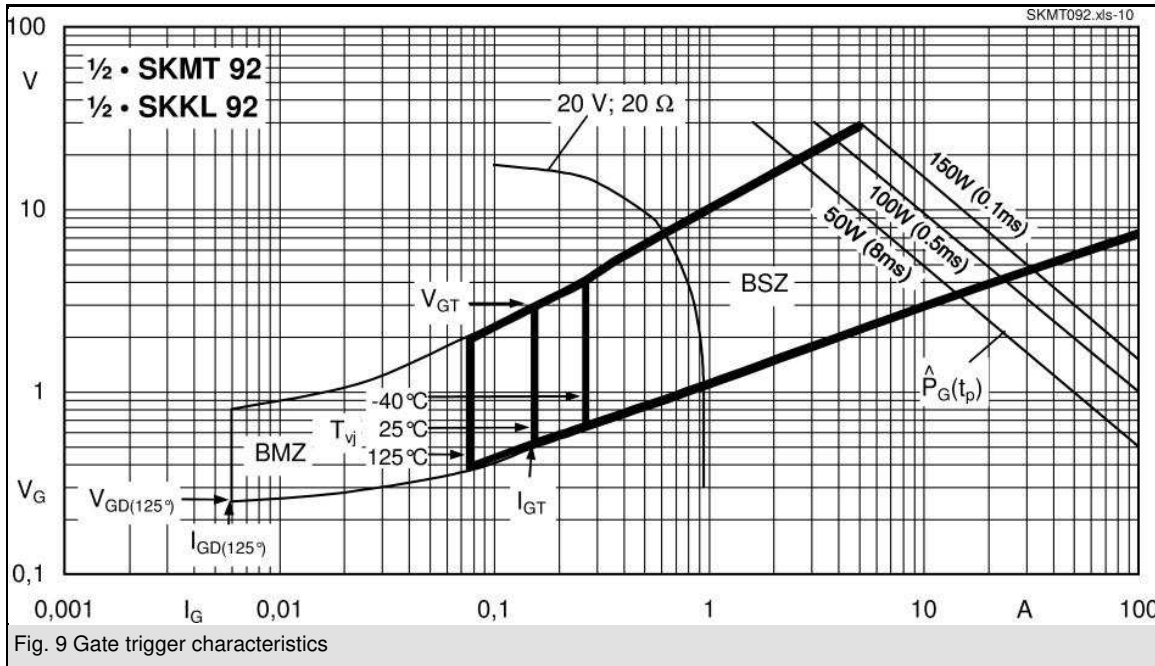

Fig. 8 Surge overload current vs. time



* The specifications of our components may not be considered as an assurance of component characteristics. Components have to be tested for the respective application. Adjustments may be necessary. The use of SEMIKRON products in life support appliances and systems is subject to prior specification and written approval by SEMIKRON. We therefore strongly recommend prior consultation of our personal.