

Product data sheet

Specifications



TeSys F contactor - 3P (3 NO) - AC-3 - <= 440 V 330 A - coil 220 V AC

LC1F330M7

! To be discontinued on: 31 December 2023

! To be end-of-service on: 31 December 2023

! To be discontinued

Product availability : Non-Stock - Not normally stocked in distribution facility

Price* : 1,621.00 USD

Main

| | |
|--------------------------------|--|
| Range | TeSys |
| Product name | TeSys F |
| Product or Component Type | Contacteur |
| Device short name | LC1F |
| Contacteur application | Motor control Resistive load |
| Utilisation category | AC-3 AC-4 AC-1 |
| Poles description | 3P |
| Power pole contact composition | 3 NO |
| [Ie] rated operational current | 400 A 104 °F (40 °C) <= 440 V AC AC-1 330 A 131 °F (55 °C) <= 440 V AC AC-3 |
| Motor power kW | 160 kW 380...400 V AC 50/60 Hz AC-3) 180 kW 415 V AC 50/60 Hz AC-3) 200 kW 440 V AC 50/60 Hz AC-3) 200 kW 500 V AC 50/60 Hz AC-3) 220 kW 660...690 V AC 50/60 Hz AC-3) 160 kW 1000 V AC 50/60 Hz AC-3) 100 kW 220...230 V AC 50/60 Hz AC-3) 59 kW 400 V AC 50/60 Hz AC-4) |
| [Uc] control circuit voltage | 220 V AC 40...400 Hz |

Complementary

| | |
|---|--|
| [Uimp] rated impulse withstand voltage | 8 kV |
| Overvoltage category | III |
| [Ith] conventional free air thermal current | 400 A 104 °F (40 °C) |
| Rated breaking capacity | 2640 A IEC 60947-4-1 |
| [Icw] rated short-time withstand current | 2650 A 104 °F (40 °C) - 10 s 1800 A 104 °F (40 °C) - 30 s 1300 A 104 °F (40 °C) - 1 min 900 A 104 °F (40 °C) - 3 min 750 A 104 °F (40 °C) - 10 min |

* Price is "List Price" and may be subject to a trade discount – check with your local distributor or retailer for actual price.

| | |
|--|---|
| Associated fuse rating | 400 A aM <= 440 V 500 A gG <= 440 V |
| Average impedance | 0.28 mOhm - lth 400 A 50 Hz |
| [Ui] rated insulation voltage | 1000 V IEC 60947-4-1 1500 V VDE 0110 group C |
| Power dissipation per pole | 44 W AC-1 31 W AC-3 |
| Mounting Support | Plate |
| Standards | EN 60947-1 EN 60947-4-1 JIS C8201-4-1 IEC 60947-4-1 IEC 60947-1 |
| Product certifications | LROS (Lloyds register of shipping) CB UL BV ABS RMRoS RINA CSA DNV UKCA |
| Connections - terminals | Control circuit screw clamp terminals 1 0.00...0.01 in ² (1...4 mm ²)flexible without cable end Control circuit screw clamp terminals 2 0.00...0.01 in ² (1...4 mm ²)flexible without cable end Control circuit screw clamp terminals 1 0.00...0.01 in ² (1...4 mm ²)flexible with cable end Control circuit screw clamp terminals 2 0.00...0.00 in ² (1...2.5 mm ²)flexible with cable end Control circuit screw clamp terminals 1 0.00...0.01 in ² (1...4 mm ²)solid without cable end Control circuit screw clamp terminals 2 0.00...0.01 in ² (1...4 mm ²)solid without cable end Power circuit lugs-ring terminals 1 0.37 in ² (240 mm ²) Power circuit bar 2 30 x 5 mm Power circuit bolted connection |
| Tightening torque | Control circuit 10.62 lbf.in (1.2 N.m) Power circuit 309.78 lbf.in (35 N.m) |
| Control circuit voltage limits | Operational 0.85...1.1 Uc 40...400 Hz 131 °F (55 °C)) Drop-out 0.35...0.55 Uc 40...400 Hz 131 °F (55 °C)) |
| Inrush power in VA | 650 VA 40...400 Hz 0.9 68 °F (20 °C)) |
| Hold-in power consumption in VA | 10 VA 40...400 Hz 0.9 68 °F (20 °C)) |
| Heat dissipation | 8 W |
| Operating time | 40...65 ms closing 100...170 ms opening |
| Mechanical durability | 10 Mcycles |
| Maximum operating rate | 2400 cyc/h 131 °F (55 °C) |
| Compatibility code | LC1F |
| Motor power range | 55...100 kW 200...240 V 3 phase 110...220 kW 480...500 V 3 phase 110...220 kW 380...440 V 3 phase |
| Motor starter type | Direct on-line contactor |
| Contactors coil voltage | 220 V AC standard |

Environment

| | |
|--|---|
| IP degree of protection | IP20 front face with shrouds IEC 60529 IP20 front face with shrouds VDE 0106 |
| Protective treatment | TH |
| Ambient Air Temperature for Operation | 23...131 °F (-5...55 °C) |
| Ambient Air Temperature for Storage | -76...176 °F (-60...80 °C) |
| Permissible ambient air temperature around the device | -40...158 °F (-40...70 °C) |
| Operating altitude | 9842.52 ft (3000 m) without derating |

| | |
|------------|-----------------------|
| Height | 8.11 in (206 mm) |
| Width | 8.39 in (213 mm) |
| Depth | 8.62 in (219 mm) |
| Net weight | 18.96 lb(US) (8.6 kg) |

Ordering and shipping details

| | |
|-----------------------|-----------------------------------|
| Category | 22336 - CTR,F-LINE,AC,OPEN,NONREV |
| Discount Schedule | I12 |
| GTIN | 3389110460254 |
| Nbr. of units in pkg. | 1 |
| Package weight(Lbs) | 20.45 lb(US) (9.277 kg) |
| Returnability | Yes |
| Country of origin | CZ |

Packing Units

| | |
|------------------------------|---------------------------|
| Unit Type of Package 1 | PCE |
| Package 1 Height | 9.84 in (25 cm) |
| Package 1 width | 9.84 in (25 cm) |
| Package 1 Length | 12.80 in (32.5 cm) |
| Unit Type of Package 2 | P06 |
| Number of Units in Package 2 | 10 |
| Package 2 Weight | 222.71 lb(US) (101.02 kg) |
| Package 2 Height | 31.50 in (80 cm) |
| Package 2 width | 31.50 in (80 cm) |
| Package 2 Length | 23.62 in (60 cm) |

Offer Sustainability

| | |
|----------------------------|---|
| Sustainable offer status | Green Premium product |
| California proposition 65 | WARNING: This product can expose you to chemicals including: Lead and lead compounds, which is known to the State of California to cause cancer and birth defects or other reproductive harm. For more information go to www.P65Warnings.ca.gov |
| REACH Regulation | REACH Declaration |
| EU RoHS Directive | Compliant EU RoHS Declaration |
| Mercury free | Yes |
| RoHS exemption information | Yes |
| China RoHS Regulation | China RoHS declaration Product out of China RoHS scope. Substance declaration for your information. |
| Environmental Disclosure | Product Environmental Profile |
| Circularity Profile | End of Life Information |
| WEEE | The product must be disposed on European Union markets following specific waste collection and never end up in rubbish bins. |

Contractual warranty

| | |
|----------|-----------|
| Warranty | 18 months |
|----------|-----------|

Dimensions and Drawings

LC1 F115 to F330

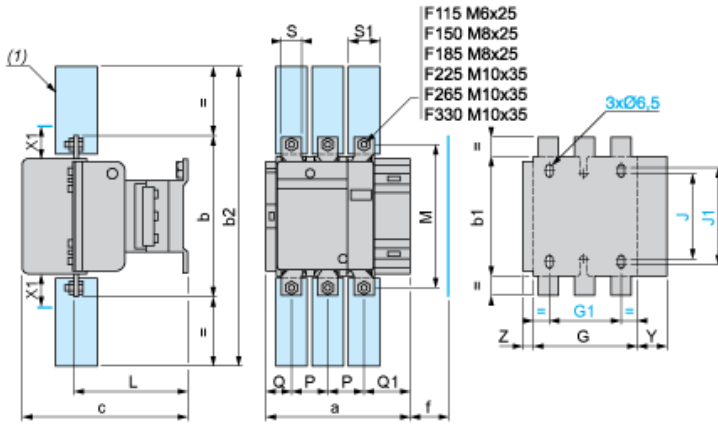

(1) Power terminal protection shroud

X1 (mm) = Minimum electrical clearance according to operating voltage and breaking capacity.

| LC1 | 200...500 V | 600...1000 V |
|------------|-------------|--------------|
| F115, F150 | 10 | 15 |
| F185 | 10 | 15 |
| F225, F265 | 10 | 15 |
| F330 | 10 | 15 |

| LC1 | | a | b | b1 | b2 | c | f | G | G1 | J | J1 | L | M | P | Q | Q1 | S | S1 | Y | Z |
|------|----|-------|-----|-----|-----|-----|-----|-------|----|-----|-----|-------|-----|----|------|------|----|------|----|------|
| F115 | 3P | 163.5 | 162 | 137 | 265 | 171 | 131 | 106 | 80 | 106 | 120 | 107 | 147 | 37 | 29.5 | 60 | 20 | 26 | 44 | 13.5 |
| | 4P | 200.5 | 162 | 137 | 265 | 171 | 131 | 143 | 80 | 106 | 120 | 107 | 147 | 37 | 29.5 | 60 | 20 | 26 | 44 | 13.5 |
| F150 | 3P | 163.5 | 170 | 137 | 301 | 171 | 131 | 106 | 80 | 106 | 120 | 107 | 150 | 40 | 26 | 57.5 | 20 | 34 | 44 | 13.5 |
| | 4P | 200.5 | 170 | 137 | 301 | 171 | 131 | 143 | 80 | 106 | 120 | 107 | 150 | 40 | 26 | 55.5 | 20 | 34 | 44 | 13.5 |
| F185 | 3P | 168.5 | 174 | 137 | 305 | 181 | 130 | 111 | 80 | 106 | 120 | 113.5 | 154 | 40 | 29 | 59.5 | 20 | 34 | 44 | 13.5 |
| | 4P | 208.5 | 174 | 137 | 305 | 181 | 130 | 151 | 80 | 106 | 120 | 113.5 | 154 | 40 | 29 | 59.5 | 20 | 34 | 44 | 13.5 |
| F225 | 3P | 168.5 | 197 | 137 | 364 | 181 | 130 | 111 | 80 | 106 | 120 | 113.5 | 172 | 48 | 21 | 51.5 | 25 | 44.5 | 44 | 13.5 |
| | 4P | 208.5 | 197 | 137 | 364 | 181 | 130 | 151 | 80 | 106 | 120 | 113.5 | 172 | 48 | 17 | 47.5 | 25 | 44.5 | 44 | 13.5 |
| F265 | 3P | 201.5 | 203 | 145 | 375 | 213 | 147 | 142 | 96 | 106 | 120 | 141 | 178 | 48 | 39 | 66.5 | 25 | 44.5 | 38 | 21.5 |
| | 4P | 244.5 | 203 | 145 | 375 | 213 | 147 | 190 | 96 | 106 | 120 | 141 | 178 | 48 | 34 | 66.5 | 25 | 44.5 | 38 | 16.5 |
| F330 | 3P | 213 | 206 | 145 | 375 | 219 | 147 | 154.5 | 96 | 106 | 120 | 145 | 181 | 48 | 43 | 74 | 25 | 44.5 | 38 | 20.5 |
| | 4P | 261 | 206 | 145 | 375 | 219 | 147 | 202.5 | 96 | 106 | 120 | 145 | 181 | 48 | 43 | 74 | 25 | 44.5 | 38 | 20.5 |

TeSys F reversing contactors and changeover contactor pairs, vertically mounted

NOTE: For customer assembly, with mechanical interlock (MI) LA9 F, fixing recommended on AM1 EC uprights (please consult your Regional Sales Office). 2 x LC1 identical or different ratings (LC1 F115 to F630 and F800).

Assembly A

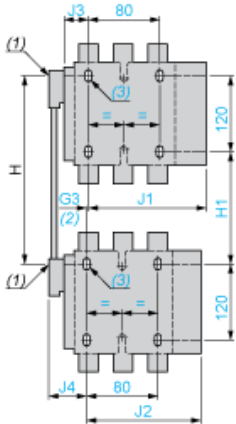

- (1) Mechanical interlock shaft.
- (2) For assembly of contactors of different ratings only.
- (3) 4 x Ø6.5 for LC1 F115 to F225.

Assembly A⁽⁷⁾ - Mechanical interlock reference

| | G3 3P | G3 4P | H min. | H max. | H1 min. | H1 max. | J1 3P | J1 4P |
|----------|-------|-------|--------|--------|---------|---------|-------|-------|
| LA9 FF4F | 0 | 0 | 200 | 310 | 80 | 190 | 137 | 155.5 |
| LA9 FG4F | 3 | 4 | 210 | 300 | 90 | 180 | 139.5 | 159.5 |
| LA9 FG4G | 0 | 0 | 220 | 310 | 100 | 190 | 139.5 | 159.5 |

| | J2 3P | J2 4P | J3 3P | J3 4P | J4 3P | J4 4P |
|----------|-------|-------|-------|-------|-------|-------|
| LA9 FF4F | 137 | 155.5 | 48.5 | 67 | 48.5 | 67 |
| LA9 FG4F | 137 | 155.5 | 53 | 73 | 54 | 69 |
| LA9 FG4G | 139.5 | 159.5 | 53 | 73 | 53 | 73 |

Assembly B

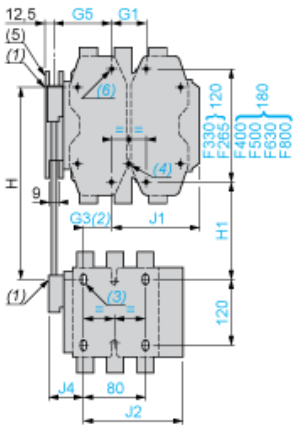

- (4) 4 x Ø6.5 for LC1 F265.
- (5) Mechanical interlock guide bracket.

Assembly B⁽⁷⁾ - Mechanical interlock reference

| | G1 3P | G1 4P | G3 3P | G3 4P | G5 3P | G5 4P | H min. | H max. |
|----------|-------|-------|-------|-------|-------|-------|--------|--------|
| LA9 FH4F | 96 | 96 | 21 | 27 | 60 | 83 | 240 | 380 |
| LA9 FJ4F | 80 | 80 | 45 | 26 | 83 | 83 | 250 | 380 |
| LA9 FK4F | 80 | 140 | 45 | 26 | 83 | 83 | 270 | 380 |
| LA9 FL4F | 180 | 240 | 35 | 17 | 74 | 74 | 310 | 380 |
| LA9 FH4G | 96 | 96 | 19 | 23 | 60 | 83 | 250 | 380 |
| LA9 FJ4G | 80 | 80 | 42 | 22 | 83 | 83 | 250 | 380 |
| LA9 FK4G | 80 | 140 | 42 | 22 | 83 | 83 | 270 | 380 |
| LA9 FL4G | 180 | 240 | 33 | 13 | 74 | 74 | 310 | 380 |

| | H1 min. | H1 max. | J1 3P | J1 4P | J2 3P | J2 4P | J4 3P | J4 4P |
|----------|---------|---------|-------|-------|-------|-------|-------|-------|
| LA9 FH4F | 110 | 250 | 157.5 | 181.5 | 137 | 155.5 | 48.5 | 67 |
| LA9 FJ4F | 80 | 210 | 144.5 | 192.5 | 137 | 155.5 | 48.5 | 67 |
| LA9 FK4F | 100 | 210 | 164.5 | 219.5 | 137 | 155.5 | 48.5 | 67 |
| LA9 FL4F | 140 | 210 | 248.5 | 328.5 | 137 | 155.5 | 48.5 | 67 |
| LA9 FH4G | 120 | 250 | 157.5 | 181.5 | 139.5 | 159.5 | 53 | 73 |
| LA9 FJ4G | 90 | 220 | 144.5 | 192.5 | 139.5 | 159.5 | 53 | 73 |
| LA9 FK4G | 110 | 220 | 164.5 | 219.5 | 139.5 | 159.5 | 53 | 73 |
| LA9 FL4G | 150 | 220 | 248.5 | 328.5 | 139.5 | 159.5 | 53 | 73 |

Assembly C

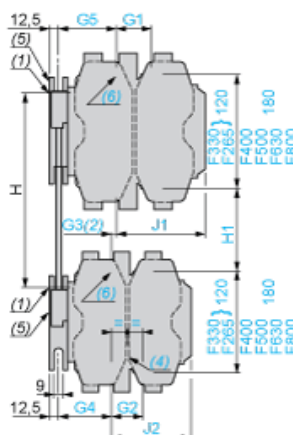

- (6) 4 x Ø8.5 for LC1 F400, F500 or 4 x Ø10.5 for LC1 F630 and F800.



(7) Only 3P for F800.

(8) In this case, G4 is greater than G5.

Assembly C⁽⁷⁾

| | G1 3P | G1 4P | G2 3P | G2 4P | G3 3P | G3 4P | G4 3P | G4 4P | G5 3P | G5 4P |
|----------|-------|-------|-------|-------|------------------|------------------|-------|-------|-------|-------|
| LA9 FH4H | 96 | 96 | 96 | 96 | 0 | 0 | 60 | 83 | 60 | 83 |
| LA9 FJ4H | 80 | 80 | 96 | 96 | 23 | 0 | 60 | 83 | 83 | 83 |
| LA9 FK4H | 80 | 140 | 96 | 96 | 23 | 0 | 60 | 83 | 83 | 83 |
| LA9 FL4H | 180 | 240 | 96 | 96 | 14 | g ⁽⁸⁾ | 60 | 83 | 74 | 74 |
| LA9 FJ4J | 80 | 80 | 80 | 80 | 0 | 0 | 83 | 83 | 83 | 83 |
| LA9 FK4J | 80 | 140 | 80 | 80 | 0 | 0 | 83 | 83 | 83 | 83 |
| LA9 FL4J | 180 | 240 | 80 | 80 | g ⁽⁸⁾ | g ⁽⁸⁾ | 83 | 83 | 74 | 74 |
| LA9 FK4K | 80 | 140 | 80 | 140 | 0 | 0 | 83 | 83 | 83 | 83 |
| LA9 FL4K | 180 | 240 | 80 | 140 | g ⁽⁸⁾ | g ⁽⁸⁾ | 83 | 83 | 74 | 74 |
| LA9 FL4L | 180 | 240 | 180 | 240 | 0 | 0 | 74 | 74 | 74 | 74 |

| | H min. | H max. | H1 min. | H1 max. | J1 3P | J1 4P | J2 3P | J2 4P |
|----------|--------|--------|---------|---------|-------|-------|-------|-------|
| LA9 FH4H | 250 | 380 | 130 | 260 | 157.5 | 181.5 | 157.5 | 181.5 |
| LA9 FJ4H | 260 | 380 | 110 | 230 | 144.5 | 192.5 | 157.5 | 181.5 |
| LA9 FK4H | 280 | 380 | 130 | 230 | 164.5 | 219.5 | 157.5 | 181.5 |
| LA9 FL4H | 330 | 380 | 170 | 220 | 248.5 | 328.5 | 157.5 | 181.5 |
| LA9 FJ4J | 260 | 380 | 60 | 200 | 144.5 | 192.5 | 144.5 | 192.5 |
| LA9 FK4J | 280 | 380 | 100 | 200 | 164.5 | 219.5 | 144.5 | 192.5 |
| LA9 FL4J | 325 | 380 | 140 | 195 | 248.5 | 329.5 | 144.5 | 192.5 |
| LA9 FK4K | 300 | 380 | 120 | 200 | 164.5 | 329.5 | 164.5 | 219.5 |
| LA9 FL4K | 345 | 380 | 160 | 195 | 248.5 | 328.5 | 164.5 | 219.5 |
| LA9 FL4L | 380 | 380 | 200 | 200 | 248.5 | 328.5 | 248.5 | 328.5 |

Connections and Schema

2, 3, and 4-pole Contactors

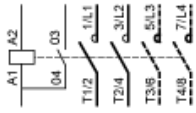

LC1 F115 to F630, F1250(coil LX1 F ~)



LC1 F115 to F630 , F1250 (coil LX4 F ≡)



LC1 F115 to F265 (coil LX9 F ~)

LC1 F800 (coil LX8 F ~ / ≡)

Recommended replacement(s)

LC1F330M7 is replaced by the following group of products:

Linking to group 1

| | | |
|----|---|--|
| 1x |  | <p>High power contactor, TeSys Giga, 3 pole (3NO), AC-3 <=440V 330A, standard version, 100...250V wide band AC/DC coil</p> <p>LC1G330KUEN</p> |
| | | |
| 1x |  | <p>High power contactor, TeSys Giga, 3 pole (3NO), AC-3 <=440V 330A, advanced version, 200...500V wide band AC/DC coil</p> <p>LC1G330LSEA</p> |